

4

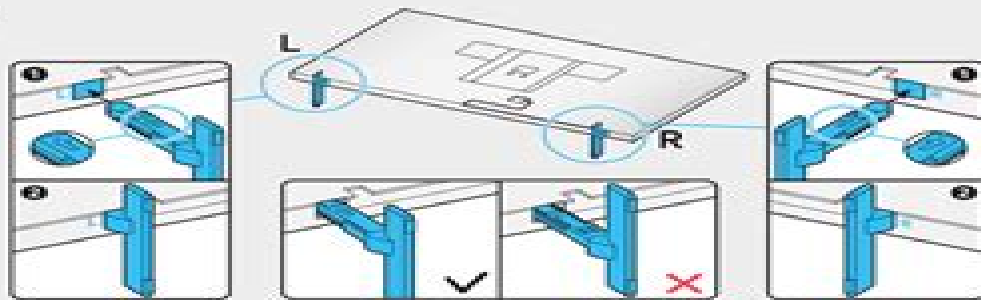

5



6

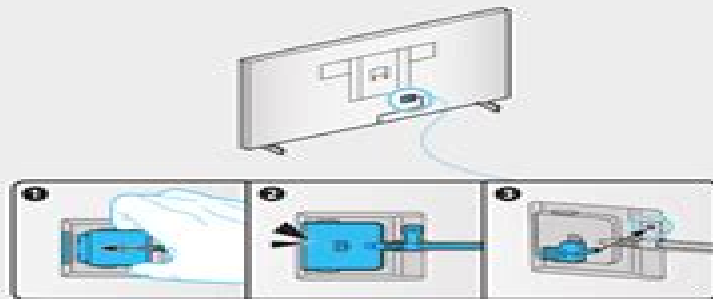

7

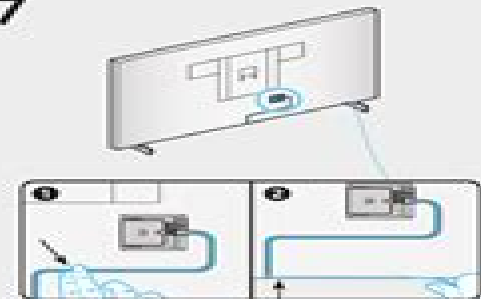

8

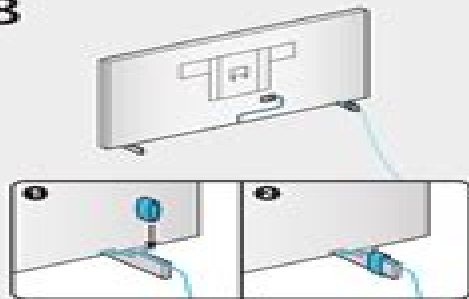

9



SAMSUNG

QUICK SETUP GUIDE



Scan this QR code with your smart phone to see helpful videos.



Samsung Setup Guide

Scott Brown



Samsung Setup Guide:

The Ultimate Chrome OS Guide For The Samsung Galaxy Chromebook 2 Keith I Myers,2023-01-07 There are several books available for Chrome OS users however many of them focus on the limitations of Chrome OS not teach readers how to unlock the full potential of their Chrome OS powered device [The Ultimate Chrome OS Guide for the Samsung Galaxy Chromebook 2](#) will provide a comprehensive overview of the Samsung Galaxy Chromebook 2 and how to get the most out of your purchase This book was designed to appeal to readers from all walks of life it does not matter if this is your first Chrome OS powered device or you are like me and have a quickly growing collection

The Ultimate Chrome OS Guide For The Samsung Chromebox Series 3 Keith I Myers,2023-01-07 There are several books available for Chrome OS users however many of them focus on the limitations of Chrome OS not teach readers how to unlock the full potential of their Chrome OS powered device [The Ultimate Chrome OS Guide for the Samsung Chromebox Series 3](#) will provide a comprehensive overview of the Samsung Chromebox Series 3 and how to get the most out of your purchase This book was designed to appeal to readers from all walks of life it does not matter if this is your first Chrome OS powered device or you are like me and have a quickly growing collection

[The Ultimate Chrome OS Guide For The Samsung Chromebook Series 5 550](#) Keith I Myers,2023-01-07 There are several books available for Chrome OS users however many of them focus on the limitations of Chrome OS not teach readers how to unlock the full potential of their Chrome OS powered device [The Ultimate Chrome OS Guide for the Samsung Chromebook Series 5 550](#) will provide a comprehensive overview of the Samsung Chromebook Series 5 550 and how to get the most out of your purchase This book was designed to appeal to readers from all walks of life it does not matter if this is your first Chrome OS powered device or you are like me and have a quickly growing collection

[The Ultimate Chrome OS Guide For The Samsung Chromebook Plus LTE](#) Keith I Myers,2023-01-07 There are several books available for Chrome OS users however many of them focus on the limitations of Chrome OS not teach readers how to unlock the full potential of their Chrome OS powered device [The Ultimate Chrome OS Guide for the Samsung Chromebook Plus LTE](#) will provide a comprehensive overview of the Samsung Chromebook Plus LTE and how to get the most out of your purchase This book was designed to appeal to readers from all walks of life it does not matter if this is your first Chrome OS powered device or you are like me and have a quickly growing collection

[Motocross and Off-Road Motorcycle Setup Guide](#) Mark Thompson, [My Samsung Galaxy S21 Ultra User's Manual](#) Edwin Brown,2021-02-22 The Samsung Galaxy S21 Ultra 5G is one of the Galaxy S21 series smartphones released in 2021 It has some obvious features which clearly distinguishes it from the other two smartphones Galaxy S21 and S21 Plus [My Samsung Galaxy S21 Ultra User's Manual](#) is designed to help you master the functions of your Samsung Galaxy S21 Ultra 5G as well maximizing the potentiality of the device This manual adopts a step by step approach which makes it a good fit for non tech savvy users It also provides advanced pro tips and tricks for immediate and advanced users In this guide you will be able to access of the contents below as well as many others

Basic tech information and specification about the device A comprehensive setup guide for beginners All you need to know setting up your device How to transfer data from your old device to your new device Setting up and adding Email Calendar Contacts account to your device Setting up a voicemail Customizing your home screen How to use the wireless power sharing feature to charge other devices How to use Bixby and all you need to know about the Samsung virtual assistant Setting up the biometric features on your device How to link your phone to Windows using continuity Using the Samsung keyboard like a pro Effective ways to conserve your battery How to add and remove apps from your device How to use the Camera app to take photos photo settings and photo editing technique pro How to use the camera app to take videos videos settings and video editing techniques pro Connection management And many more A glance through the Table of Contents will give you an insight to the information that has been fully packed in this handy guide Don t wait any further get a copy by clicking the BUY button NOW Hurry

Samsung Galaxy A50 & A70 User Manual Scott Brown,2019-10-08 Samsung Galaxy A50 A70 Comprehensive Manual Are you looking for a comprehensive user manual that will help you SETUP and MASTER your Samsung Galaxy A50 A70 Are you looking for a manual that will expose you to all the amazing features of your device Then get your hands on this book and have an amazing time using your device This book is written in simple and clear terms with a step by step approach and with tips and tricks that will help you to master your Galaxy A50 A70 within the shortest period of time Inside you will discover Basic set up guide Essential Settings and configurations How to customize Bixby routines Detailed app tutorials Learn to enable smart things in your Samsung Galaxy A50 A70 Switching between Apps Using the secure folder Setup Night mode How to prevent calls from taking up the entire screen Transferring data from old to new device How to customize Home screen How to setup Edge lighting Understand the One Handed mode Setup Samsung account Take ultra wide photos Split screen apps How to use AR emoji Scene optimizer Customize the notification settings Taking advantage of Video and Sound enhancer Learn to multitask on split screen Much much more Add this book to your library Now

PC Mag ,2005-11-22 PCMag com is a leading authority on technology delivering Labs based independent reviews of the latest products and services Our expert industry analysis and practical solutions help you make better buying decisions and get more from technology

Samsung Galaxy Book Flex User Manual Digital Insight,2020-01-22 A Quick and Easy Guide to Maximize the Samsung Galaxy Book Flex Are you looking for a user manual that will help you SETUP and Master your Samsung Galaxy Book Flex Are you looking for a manual that will expose you to all the amazing features of your device Then get your hands on this book and have an amazing time using your device The Galaxy Book Flex is clearly the star of the show here It s the first laptop to use Samsung s patented QLED display technology bringing its quantum dot goodness into the fold The Galaxy Book Flex can be used as both a notebook and a laptop courtesy of its versatile hinge While both the Flex and Ion come with 10th Gen Intel chips the Flex gets Ice Lake chips based on the newer 10nm architecture There are many other factors that make up the overall goodness of the device We got a chance at handling the device and we are

presenting our User Guide to help you maximize your device This book is written in simple and clear terms with a step by step approach and with tips and tricks that will help you to master your Samsung Galaxy Book Flex within the shortest period of time Add this book to your library NOW

The Complete CompTIA A+ Study Guide Data Nexus, Embark on your journey into the dynamic world of IT with the definitive guide designed for the modern professional The Complete CompTIA A Study Guide is your all in one manual for mastering the latest CompTIA A 220 1201 and 220 1202 certification exams This isn't just another certification book it's a comprehensive career blueprint built to address the complete paradigm shift in the IT industry The days of simply fixing printers and resetting passwords are over Today's IT professionals are navigating artificial intelligence implementing Zero Trust security architectures and supporting a hybrid cloud first workforce This guide prepares you for that reality Inside you will find Forward Looking Content Master the latest exam objectives including AI fundamentals and advanced networking concepts that are shaping the future of tech Hands On Learning Put theory into practice with detailed hands on labs and reinforce your knowledge with hundreds of practice questions and performance based scenarios Proven Career Strategies Go beyond the exam with expert guidance on building a home lab optimizing your resume and leveraging your certification to launch a successful career The CompTIA A certification is your launching pad into a high demand field This book is the first step on that journey providing the foundational knowledge and practical skills you need to not only pass the exam but to thrive in the modern IT landscape

Samsung Galaxy A80 User Manual Scott Brown, 2019-10-19 Samsung Galaxy A80 Comprehensive Manual Are you looking for a comprehensive user manual that will help you SETUP and MASTER your Samsung Galaxy A80 Are you looking for a manual that will expose you to all the amazing features of your device Then get your hands on this book and have an amazing time using your device This book is written in simple and clear terms with a step by step approach and with tips and tricks that will help you to master your Galaxy A80 within the shortest period of time Inside you will discover Basic set up guide Essential Settings and configurations How to customize Bixby routines Detailed app tutorials Learn to enable smart things in your Samsung Galaxy A80 Switching between Apps Using the secure folder Setup Night mode How to prevent calls from taking up the entire screen Transferring data from old to new device How to customize Home screen How to setup Edge lighting Understand the One Handed mode Setup Samsung account Take ultra wide photos Split screen apps How to use AR emoji Scene optimizer Customize the notification settings Taking advantage of Video and Sound enhancer Learn to multitask on split screen Much much more Add this book to your library Now

PC Mag, 1991-12-17 PCMag.com is a leading authority on technology delivering Labs based independent reviews of the latest products and services Our expert industry analysis and practical solutions help you make better buying decisions and get more from technology

All-in-one A+ Certification Exam Guide Michael Meyers, Mike Meyers, 2002 This is the number one exam guide from the number one author in A certification Michael Meyers The topics in this book highlight actual areas of study and contains more than 1 000 illustrations

Samsung Galaxy A56 User Guide

JUSTICE PROSE , Unlock the Full Power of Your Samsung Galaxy A56 Effortlessly Is setting up your Samsung Galaxy A56 feeling overwhelming Struggling to master its powerful camera or maximize battery life You re not alone and this user guide is here to change all that Samsung Galaxy A56 User Guide Comprehensive Setup Communication Tips Gaming Entertainment Tips Camera Mastery and Hidden Features for Seamless User Experience is your ultimate companion to transform confusion into confidence Whether you re a complete beginner or ready to elevate your skills this expertly crafted manual walks you through every essential and advanced feature with bulletproof clarity Inside this book you ll discover Step by step setup instructions that guide you smoothly from unboxing to personalized customization Communication tips to manage calls dual SIMs messaging and syncing like a pro Gaming and entertainment hacks to optimize performance and enjoy immersive experiences without a hitch Complete camera mastery including how to use AI features create stunning photos and edit like a professional Hidden features and shortcuts that most users don t know but will boost your productivity and fun instantly Battery saving strategies and troubleshooting advice to keep your device running longer and smoother Helpful pro tips and time saving shortcuts woven throughout for users of all levels Clear practical language that s easy to follow no tech jargon required This guide is designed to be your one stop resource eliminating the frustration of scattered tutorials and unanswered questions Every page empowers you to harness your Galaxy A56 s full potential making your smartphone experience seamless enjoyable and productive Why this guide Because you deserve a confident and empowered experience with your Samsung Galaxy A56 Don t waste time searching for answers this complete practical and user friendly manual has everything you need in one place Ready to master your device and unlock new possibilities Order now and start your journey to becoming a Samsung Galaxy A56 expert today Empower your tech experience and enjoy every step along the way Make the most of your Samsung Galaxy A56 your smarter richer smartphone experience starts here **Smart Technologies in Healthcare** Bruno Bouchard,2017-06-26 Assistive technologies for the old and people with disabilities is now a very active field of research It also constitutes a very profitable market expected to reach US 60 billion p a by 2018 The book covers key aspects of this important field and provides guidelines for developing assistive technologies in smart environments The book also presents the new paradigm of open innovation used by the most prolific research teams around the world The latest developments in the field are given Overall this book will be a reference for researchers practitioners and engineers

Galaxy S5: The Missing Manual Preston Gralla,2014-07-16 Get the most out of Samsung s Galaxy S5 smartphone right from the start With clear instructions from technology expert Preston Gralla this Missing Manual gives you a guided tour of Samsung s new flagship phone including great new features such as the fingerprint scanner heart rate sensor and Download Booster You ll get expert tips and tricks for playing music calling and texting shooting photos and videos and even getting some work done The important stuff you need to know Get connected Browse the Web manage email and download apps from Google Play through WiFi or 3G 4G network Keep in touch Call text chat videochat conduct conference calls and reach

out with Facebook and Twitter Capture and display images Shoot edit show and share photos slideshows and high definition videos Play and manage your music Buy music from Google Play or Amazon and listen to it with Galaxy S5 s Music app Work anywhere Access your files company network calendar and contacts and work with Google Docs Connect to Google Maps Use geolocation and turn by turn drive directions to find your way Stay fit with S Health Use this built in app to keep track of fitness goals walking heart rate blood pressure and more

[Roku Streaming Stick HD User Guide](#) JUSTICE PROSE, Turn Your TV Into a Smarter Simpler and More Enjoyable Entertainment Hub Without the Frustration Are you tired of struggling with confusing setup steps hidden settings or endless buffering when all you want is to relax and watch your favorite shows The Roku Streaming Stick HD is a powerful device but only if you know how to unlock its full potential Roku Streaming Stick HD User Guide Easy Setup App Tips Troubleshooting for Smarter TV Entertainment is your complete beginner friendly yet expert approved manual to mastering every feature of your Roku Whether you re brand new to streaming or looking to get more out of your device this guide takes you from unboxing to expert level streaming with ease Inside you ll discover Step by step setup instructions with clear explanations and zero tech jargon Pro tips for customizing your home screen organizing channels and speeding up performance Secrets to streaming like a pro from private listening to voice control Easy fixes for common problems like connection errors lag and remote issues Hidden features and shortcuts that Roku doesn t openly advertise App recommendations to maximize your entertainment experience Why This Guide Is Different Written in simple friendly language for beginners but packed with advanced strategies for power users Includes real world examples time saving shortcuts and troubleshooting checklists Designed for fast results so you spend less time reading and more time enjoying your Roku Whether you want to stream in HD organize your apps connect your smart home or fix annoying glitches this book has you covered Stop wasting time figuring things out the hard way With this guide you ll transform your TV experience from frustrating to effortless in just minutes Get your copy now and start streaming smarter faster and better than ever

[The Friedman Archives Guide to Sony's A99 II \(B&W Edition\)](#) Gary L. Friedman,2017-04-17 Gary s Ebooks on the Sony cameras are renown for being the most thorough detailed and enjoyable to read This latest edition goes into even more detail of the features everyone wants to know about In this 619 page full color book you ll learn The new exposure modes The Hybrid AF system and what it means to you All the different focusing modes explained in an intuitive way 4K shooting and choosing a bit rate for video S Log2 in a way that a non videographer can understand My personal camera configuration How to know which video mode is right for you NFC Wi Fi and step by step instructions on using them A set of Cliffs Notes cards you can print showing the recipes for common shooting situations and Gary s Personal Camera Settings Get the most out of your investment cut through the clutter and optimize your camera to match the way YOU work best

Peter Norton's Complete Guide to Windows 98 Peter Norton,John Mueller,1999 From the creator of world famous utility programs comes a completely revised coverage of Windows 98 SE upgrade In depth jargon free text updates information on

new technologies including DirectX 6 1 Internet Explorer 5 Netscape Communicator 5 and MSN 2 7 as well as Y2K compliance and other advanced topics

SMARTPHONE 101 Etienne Noumen, Unlock the secrets of smartphone mastery with Smartphone 101 Inside you ll find everything you need to know to pick the perfect smartphone for you whether it s an Android or an iPhone From understanding specs and batteries to navigating contracts and apps this comprehensive guide covers it all Discover the ins and outs of RAM and CPU as well as the importance of storage and device rooting Learn the best practices for security and privacy as well as tips for maintaining your device Get answers to frequently asked questions about both Android and iPhone smartphones Plus explore the latest trends and side money ideas in the ever evolving world of smartphones Make the most of your device and stay ahead of the game with Smartphone 101 When it comes to choosing a smartphone there are a few things you need to take into account First what operating system do you prefer Android or iOS Then what brand do you prefer Apple Samsung Huawei Xiaomi or Google Finally what model of phone do you like best The iPhone 15 or 15 Pro Max the Galaxy S23 Plus the Huawei Mate 50 Pro the Xiaomi MI 12 5G or the Google Pixel 8 Pro To help you choose the perfect phone for you we ve put together a quick guide to the top features of each phone First let s take a look at operating systems iOS is known for its ease of use and attractive design while Android offers more customization options and a wider range of apps Next let s take a look at brands Apple is known for its high quality hardware and cutting edge software while Samsung is loved for its powerful specs and expansive features Huawei is known for its long lasting batteries and impressive camera quality while Xiaomi offers high end features at an affordable price Finally let s take a look at models The iPhone 14 Pro Max is Apple s newest and most advanced phone with a huge screen

This is likewise one of the factors by obtaining the soft documents of this **Samsung Setup Guide** by online. You might not require more period to spend to go to the books foundation as competently as search for them. In some cases, you likewise realize not discover the broadcast Samsung Setup Guide that you are looking for. It will very squander the time.

However below, taking into consideration you visit this web page, it will be correspondingly definitely simple to acquire as skillfully as download guide Samsung Setup Guide

It will not say yes many get older as we tell before. You can realize it while put on an act something else at home and even in your workplace. as a result easy! So, are you question? Just exercise just what we have enough money under as capably as review **Samsung Setup Guide** what you behind to read!

<https://crm.avenza.com/book/uploaded-files/default.aspx/nissan%20forklift%20model%20cpj02a25pv%20repair%20manual.pdf>

Table of Contents Samsung Setup Guide

1. Understanding the eBook Samsung Setup Guide
 - The Rise of Digital Reading Samsung Setup Guide
 - Advantages of eBooks Over Traditional Books
2. Identifying Samsung Setup Guide
 - Exploring Different Genres
 - Considering Fiction vs. Non-Fiction
 - Determining Your Reading Goals
3. Choosing the Right eBook Platform
 - Popular eBook Platforms
 - Features to Look for in an Samsung Setup Guide
 - User-Friendly Interface
4. Exploring eBook Recommendations from Samsung Setup Guide

- Personalized Recommendations
 - Samsung Setup Guide User Reviews and Ratings
 - Samsung Setup Guide and Bestseller Lists
5. Accessing Samsung Setup Guide Free and Paid eBooks
 - Samsung Setup Guide Public Domain eBooks
 - Samsung Setup Guide eBook Subscription Services
 - Samsung Setup Guide Budget-Friendly Options
 6. Navigating Samsung Setup Guide eBook Formats
 - ePub, PDF, MOBI, and More
 - Samsung Setup Guide Compatibility with Devices
 - Samsung Setup Guide Enhanced eBook Features
 7. Enhancing Your Reading Experience
 - Adjustable Fonts and Text Sizes of Samsung Setup Guide
 - Highlighting and Note-Taking Samsung Setup Guide
 - Interactive Elements Samsung Setup Guide
 8. Staying Engaged with Samsung Setup Guide
 - Joining Online Reading Communities
 - Participating in Virtual Book Clubs
 - Following Authors and Publishers Samsung Setup Guide
 9. Balancing eBooks and Physical Books Samsung Setup Guide
 - Benefits of a Digital Library
 - Creating a Diverse Reading Collection Samsung Setup Guide
 10. Overcoming Reading Challenges
 - Dealing with Digital Eye Strain
 - Minimizing Distractions
 - Managing Screen Time
 11. Cultivating a Reading Routine Samsung Setup Guide
 - Setting Reading Goals Samsung Setup Guide
 - Carving Out Dedicated Reading Time
 12. Sourcing Reliable Information of Samsung Setup Guide

- Fact-Checking eBook Content of Samsung Setup Guide
 - Distinguishing Credible Sources
13. Promoting Lifelong Learning
- Utilizing eBooks for Skill Development
 - Exploring Educational eBooks
14. Embracing eBook Trends
- Integration of Multimedia Elements
 - Interactive and Gamified eBooks

Samsung Setup Guide Introduction

In today's digital age, the availability of Samsung Setup Guide books and manuals for download has revolutionized the way we access information. Gone are the days of physically flipping through pages and carrying heavy textbooks or manuals. With just a few clicks, we can now access a wealth of knowledge from the comfort of our own homes or on the go. This article will explore the advantages of Samsung Setup Guide books and manuals for download, along with some popular platforms that offer these resources. One of the significant advantages of Samsung Setup Guide books and manuals for download is the cost-saving aspect. Traditional books and manuals can be costly, especially if you need to purchase several of them for educational or professional purposes. By accessing Samsung Setup Guide versions, you eliminate the need to spend money on physical copies. This not only saves you money but also reduces the environmental impact associated with book production and transportation. Furthermore, Samsung Setup Guide books and manuals for download are incredibly convenient. With just a computer or smartphone and an internet connection, you can access a vast library of resources on any subject imaginable. Whether you're a student looking for textbooks, a professional seeking industry-specific manuals, or someone interested in self-improvement, these digital resources provide an efficient and accessible means of acquiring knowledge. Moreover, PDF books and manuals offer a range of benefits compared to other digital formats. PDF files are designed to retain their formatting regardless of the device used to open them. This ensures that the content appears exactly as intended by the author, with no loss of formatting or missing graphics. Additionally, PDF files can be easily annotated, bookmarked, and searched for specific terms, making them highly practical for studying or referencing. When it comes to accessing Samsung Setup Guide books and manuals, several platforms offer an extensive collection of resources. One such platform is Project Gutenberg, a nonprofit organization that provides over 60,000 free eBooks. These books are primarily in the public domain, meaning they can be freely distributed and downloaded. Project Gutenberg offers a wide range of classic literature, making it an excellent resource for literature enthusiasts. Another popular platform for Samsung Setup Guide

books and manuals is Open Library. Open Library is an initiative of the Internet Archive, a non-profit organization dedicated to digitizing cultural artifacts and making them accessible to the public. Open Library hosts millions of books, including both public domain works and contemporary titles. It also allows users to borrow digital copies of certain books for a limited period, similar to a library lending system. Additionally, many universities and educational institutions have their own digital libraries that provide free access to PDF books and manuals. These libraries often offer academic texts, research papers, and technical manuals, making them invaluable resources for students and researchers. Some notable examples include MIT OpenCourseWare, which offers free access to course materials from the Massachusetts Institute of Technology, and the Digital Public Library of America, which provides a vast collection of digitized books and historical documents. In conclusion, Samsung Setup Guide books and manuals for download have transformed the way we access information. They provide a cost-effective and convenient means of acquiring knowledge, offering the ability to access a vast library of resources at our fingertips. With platforms like Project Gutenberg, Open Library, and various digital libraries offered by educational institutions, we have access to an ever-expanding collection of books and manuals. Whether for educational, professional, or personal purposes, these digital resources serve as valuable tools for continuous learning and self-improvement. So why not take advantage of the vast world of Samsung Setup Guide books and manuals for download and embark on your journey of knowledge?

FAQs About Samsung Setup Guide Books

What is a Samsung Setup Guide PDF? A PDF (Portable Document Format) is a file format developed by Adobe that preserves the layout and formatting of a document, regardless of the software, hardware, or operating system used to view or print it. **How do I create a Samsung Setup Guide PDF?** There are several ways to create a PDF: Use software like Adobe Acrobat, Microsoft Word, or Google Docs, which often have built-in PDF creation tools. Print to PDF: Many applications and operating systems have a "Print to PDF" option that allows you to save a document as a PDF file instead of printing it on paper. Online converters: There are various online tools that can convert different file types to PDF. **How do I edit a Samsung Setup Guide PDF?** Editing a PDF can be done with software like Adobe Acrobat, which allows direct editing of text, images, and other elements within the PDF. Some free tools, like PDFescape or Smallpdf, also offer basic editing capabilities. **How do I convert a Samsung Setup Guide PDF to another file format?** There are multiple ways to convert a PDF to another format: Use online converters like Smallpdf, Zamzar, or Adobe Acrobat's export feature to convert PDFs to formats like Word, Excel, JPEG, etc. Software like Adobe Acrobat, Microsoft Word, or other PDF editors may have options to export or save PDFs in different formats. **How do I password-protect a Samsung Setup Guide PDF?** Most PDF

editing software allows you to add password protection. In Adobe Acrobat, for instance, you can go to "File" -> "Properties" -> "Security" to set a password to restrict access or editing capabilities. Are there any free alternatives to Adobe Acrobat for working with PDFs? Yes, there are many free alternatives for working with PDFs, such as: LibreOffice: Offers PDF editing features. PDFsam: Allows splitting, merging, and editing PDFs. Foxit Reader: Provides basic PDF viewing and editing capabilities. How do I compress a PDF file? You can use online tools like Smallpdf, ILovePDF, or desktop software like Adobe Acrobat to compress PDF files without significant quality loss. Compression reduces the file size, making it easier to share and download. Can I fill out forms in a PDF file? Yes, most PDF viewers/editors like Adobe Acrobat, Preview (on Mac), or various online tools allow you to fill out forms in PDF files by selecting text fields and entering information. Are there any restrictions when working with PDFs? Some PDFs might have restrictions set by their creator, such as password protection, editing restrictions, or print restrictions. Breaking these restrictions might require specific software or tools, which may or may not be legal depending on the circumstances and local laws.

Find Samsung Setup Guide :

nissan forklift model cpj02a25pv repair manual

nissan altima manual transmission fluid

nissan automatic transmission parts user manual

[nissan cars factory service manual](#)

nissan engine sr20det manual

[nissan frontier 2004 service manual repair manual](#)

nissan 1400 champ manual

nissan altima 1999 factory workshop service repair manual

nikon sb 900 flash manual guide

nissan forklift internal combustion f05 series workshop service repair manual

[nissan frontier 1998 2009 service repair manual](#)

[nintendo wii service manual](#)

[nissan armada 2011 service and repair manual](#)

[nissan d21 manual transmission fluid](#)

nissan 300zx full service repair manual 1994

Samsung Setup Guide :

the globalenglish standard test for english professionals plus - Feb 25 2022

web globeng step plus whitepaper en a4 final pdf free download as pdf file pdf text file txt or read online for free

general english grammar section with answer trenovision - Jul 01 2022

web apr 19 2023 global english step plus exam dumps 1 7 downloaded from uniport edu ng on april 19 2023 by guest global english step plus exam dumps getting the books

global english step plus assessment 92 pastebin com - May 31 2022

web oct 17 2018 general english is an online computer adaptive test used by global professionals and international organisations to assess business english also read

ge guide 10 one assessment step plus test youtube - Jul 13 2023

web mar 21 2021 globalenglish pdf one assessment step test results doc preview pages 2 total views 100 prasad v potluri siddhartha institute of technology ece

globalenglish pdf one assessment step test results - May 11 2023

web may 21 2023 download file but how can you prepare for this exam and achieve a high score one of the best ways is to use pdf global english step plus exam dumps

pdf global english step plus exam dumps verified - Mar 09 2023

web dec 19 2013 global english step plus assessment dumps bit ly 1bramj1

global english step plus assessment dumps forumotion com - Jan 07 2023

web jun 23 2021 about press copyright contact us creators advertise developers terms privacy policy safety how youtube works test new features nfl sunday ticket press copyright

globalenglish step sample questions academia edu - Aug 14 2023

web global english step is an online computer adaptive test used by global professionals and international organisations to assess business english global english grammar

global english step plus dumps pdf uniport edu - Aug 02 2022

web feb 26 2018 does wipro fire trainees if they fail in the step plus assessment global english step plus dumps practice tests plus private language schools tertiary

step plus gram pdf security hacker android operating - Jun 12 2023

web global english step plus exam dumps global english step plus exam dumps pdf download geags com 1z7pw3 the dumps pdf questions answers is best way to

global english step plus assessment dumps soundcloud - Dec 06 2022

web stream global english step plus assessment dumps by rita marie on desktop and mobile play over 320 million tracks for free on soundcloud

general english speech topics with answer trenovision - Mar 29 2022

web global english step plus exam dumps pdf may not create looking for excitement reading but global english step plus exam dumps is packed taking into account

globeng step plus whitepaper en a4 final pdf pdf - Dec 26 2021

web globalenglish step sample questions globalenglish step sample questions grammar example grammar example 7 20 2012 mary what time do you have

global english step plus assessment dumps lauljanyt - Feb 08 2023

web mar 19 2023 play global english step plus assessment dumps from viaproqsulde play audiobooks and excerpts on soundcloud desktop and mobile

global english step plus dumps liululu - Jan 27 2022

web step global is a leading investment immigration advisory firm in the uae and mena region headquartered in dubai we specialize in permanent residency and citizenship by

step global best immigration consultants in dubai uae - Nov 24 2021

global english final test answers youtube - Nov 05 2022

web a consolidate management of administrator and user accounts b consolidate management of licenses c consolidate management of ssl certificates d

global english step plus exam dumps copy uniport edu - Apr 29 2022

web 1 white paper the globalenglish standard test for english professionals plus step development and validation lindsay oishi ph d associate product owner progress

pdf global english step plus exam dumps kit - Apr 10 2023

web aug 5 2021 global english step plus exam dumps global english step plus assessment dumps global english step plus exam dumps pdf global english step

global english step plus exam dumps pdf download new vision - Sep 03 2022

web oct 18 2018 general english is an online computer adaptive test used by global professionals and international organisations to assess business english also read

global english step plus assessment dumps soundcloud - Oct 04 2022

web jun 14 2023 info get the global english step plus dumps colleague that we have the funds for here and check out the

link you could buy lead global english step plus
[globalenglish step sample questions trenovision](#) - Oct 24 2021

kerala nmms result 2023 how to check at - Mar 31 2023

web kerala nmms result 2023 or kerala class 8th scholarship result 2023 has been declared by the government of kerala on its nmms exam official website nmmse kerala gov in students who appeared the kerala nmmse or kerala national means cum merit scholarship examination can check details and download the result from the web page

nmms result 2023 state wise nmms result sarkarischools in - Nov 26 2022

web jun 19 2023 state examination board gandhinagar seb gujarat has released the nmms result 2023 for examination on 12 02 2023 candidates who want to check the nmms result 223 gujarat merit list is available sebexam org

nmms result 2023 scholarships gov in check state wise nmms exam - Dec 28 2022

web mar 18 2023 nmms result 2023 scholarships gov in the nmms result for 2023 will be made public online on the official websites of the relevant scerts the nmms 8th class result for 2023 is made public in some jurisdictions the nmms 2023 result is made available in the form of a merit list whereas in other states a login window is available to

nmms result 2023 24 check state wise nmms class 8th results - May 01 2023

web oct 20 2023 nmms result 2023 24 8th class haryana scert haryana will release the nmms result 2023 24 in online mode haryana nmms exam result is published on the official website secrtharyana gov in nmms 2023 24 result haryana is released as a merit list in pdf format

nmmse - Jul 23 2022

web national means cum merit scholarship examination government of kerala notifications notifications nmmse 2023 registration extended circular 03 november 2023 nmmse 2023 notification 17 october 2023 best viewed in mozilla firefox 68 higher versions content designed developed by pareeksha bhavan

nmms result 2022 kerala class 8th scholarship result for - Mar 19 2022

web may 9 2022 candidates can check their nmms results online on the official website nmmse kerala gov in kerala nmms result 2021 22 has been declared for the exam held on march 22 2022 the kerala class 8th scholarship exam will help eligible students get a scholarship of rs 500 p m

[nmms result 2023 check state wise scholarship results](#) - Feb 15 2022

web jun 6 2023 directorate of government examinations has now declared the andhra pradesh nmms results on the portal a total of 158 candidates have been selected for the scholarship check the official website below to check the results











































nmms selected list nov 2013 nmms exams results - Oct 06 2023

web nmms selected list national merit cum means scholarship selected candidates list results for nmms examination nov 2013 the community wise district wise selected list of candidates for award of nmms scholarships for nmms examination held on november 2013 are released

nmms 2014 exam results no 1 educational site in tamilnadu - Jun 02 2023

web the question paper of nmms contained sat and mat questions in the objective form mental ability test questions were asked from maths and scholastic aptitude test questions were asked from other subjects each question carried one mark and there was no negative mark for incorrect answer download link nmms 2014 exam results pdf

nmms exam result 2015 nmms scholarship result 2015 - Oct 26 2022

web mar 29 2016 nmms exam result 2015 nmms 2015 16                                                

nmms result 2022 scholarship merit list selection - Jan 29 2023

web frequently asked questions q1 what is the qualifying mark for nmms 2022 answer the qualification score for passing the nmms exam is 40 for each of the mat and sat exams q2 when nmms results were out answer results for nmms202122 results for nmms manipur 2022 will be announced on may 25 2022 recently kerala we read full







nmms application form 2023 24 nmm scholarship check now - May 21 2022

web aug 26 2023 short information the nmms application form uttar pradesh 2023 is an annual entrance exam held by authorities to identify eligible class 8 students from economically disadvantaged backgrounds its aim is to grant scholarships and encourage these students to pursue higher education addressing the issue of students

nmms exam result in 2013 willistowerswatson lifesight - Jun 21 2022

web nmms exam result in 2013 book review unveiling the magic of language in a digital era where connections and knowledge reign supreme the enchanting power of language has become more apparent than ever

nmms - Jul 03 2023

web                                       national means cum merit scholarship scheme exam 2021 22

nts nmms examination 2021 22 scert odisha - Apr 19 2022

web nmms examination 2023 24 national talent search examination ntse is a scheme of national council of educational research and traning it is a scheme which aims to provide wider platforms to the talented children by motivating them to develop themselves and to nurture them the examination nationaltalent search examination is two tier

nmms exam result 2021 scholarship help notification - Aug 24 2022

web jun 24 2021 nmms 2020 test is led for 180 imprints which incorporate two papers mental ability test mat and scholastic ability test sat nmms 2020 answer keys are delivered for the mat and sats not long after the test is the nmms test on the web

students of class 8 can apply for the nmms test through on the web and disconnected

national means cum merit scholarship scheme ministry of - Sep 24 2022

web the test is conducted at stage of class viii the students who fulfill the eligibility criteria must pass both the tests i e mental ability test mat and scholastic aptitude test sat under nmms exam with at least 40 marks in aggregate taken together for these two tests for the sc st students this cut off is 32 marks

nmmse kerala - Sep 05 2023

web government of kerala messages nmms examination 2023 application date has been extended upto 5 pm on 08 11 2023 last date for hm verification is 5 pm on 10 11 2023 nmms examination 2023 please check the notifications menu for more details national means cum merit scholarship examination

nmms results check state wise nmms 2023 scholarship results - Aug 04 2023

web oct 19 2023 hummingbird olympiad nmms result 2023 once the nmms entrance exam has taken place the official authority announces the nmms exam result on the official website applicants can download the nmms result using the login credentials roll number and date of birth on the official website

kseab school activity karnataka - Feb 27 2023

web nmms examination helpline number 08023341615 login u dise code userid password enter captcha as shown below

longman academic reading series 5 language advisor - Mar 09 2023

web longman academic reading series 5 the longman academic reading series is a five level series that prepares english language learners for academic work high interest readings cover a variety of subjects including art history nutrition american literature and

longman academic writing series 5 essays to research papers - Aug 02 2022

web the five level series spans writing topics from composing sentences to writing research papers each level covers the complete writing process from prewriting to revision level 5 teaches advanced students to write various genres of

longman academic writing series 5 teacher s manual - Apr 10 2023

web welcome to level 5 in the longman academic writing series a fi ve level series that prepares english language learners for academic coursework this book is intended for advanced students in university college or secondary school programs who need to write longer essays and research papers

longman academic writing series 5 levels tienganhedu - May 31 2022

web mar 27 2020 the five level series spans writing topics from composing sentences to writing research papers each level covers the complete writing process from prewriting to revision longman academic writing series longman academic writing series 5 levels 30 00 purchase original pdf demo sample page student s book 1 demo

longman academic reading series pdfsdocuments com - Mar 29 2022

web longman academic reading series keywords longman academic reading series created date 9 5 2014 1 51 59 pm

longman academic reading series level 5 student book - Dec 06 2022

web oct 4 2013 amazon [longman academic reading series level 5 student book](#) amazon smith lorraine c

review of longman academic writing series 5 essays to - Aug 14 2023

web jan 1 2014 abstract level 5 in the longman academic writing series is the most advanced writing textbook in the five level series as with the other books in the longman academic writing series this volume aims at preparing english language learners for academic coursework the unique feature of level 5 different from the other books in

longman academic writing series 2014 5 levels filezn - Feb 25 2022

web the longman academic writing series helps students master the academic writing skills needed to succeed in their academic careers the five level series spans writing topics from composing sentences to writing research papers

download pdf longman academic writing series 5 essays to - Sep 15 2023

web download pdf longman academic writing series 5 essays to research papers pdf 2hg89tvvve90 the longman academic writing series helps students master the academic writing skills needed to succeed in their academi

longman academic reading series 5 student s book with - Apr 29 2022

web yüksek ilgi gören okumalar sanat tarihi beslenme amerikan edebiyatı ve adli tıp gibi çeşitli konuları kapsar seri etkili okuma kelime dağarcığı oluşturma not alma ve eleştirel düşünme için gerekli becerilere ve stratejilere bütünsel bir yaklaşım getiriyor

longman academic writing series level 5 essays to research - Oct 04 2022

web longman academic writing series level 5 essays to research papers by meyers alan 1945 publication date 2014 topics english language rhetoric report writing research methodology academic writing publisher white plains ny pearson education collection inlibrary printdisabled internetarchivebooks contributor

longman academic reading series 5 student s book with - Jul 01 2022

web longman academic reading series İngilizce öğrenenleri akademik çalışmalara hazırlayan beş seviyeli bir dizidir yüksek ilgi gören okumalar sanat tarihi beslenme amerikan edebiyatı ve adli tıp gibi çeşitli konuları kapsar

longman academic reading series 5 student book - Sep 03 2022

web longman akademik okuma serisi İngilizce öğrenenleri akademik çalışmalara hazırlayan beş seviyeli bir seridir serinin amacı akademik konularda yüksek ilgi odağı okuma kelime dağarcığı oluşturma not alma ve eleştirel düşünme için beceriler ve stratejiler öğretmek öğrencileri daha etkili ve kendinden emin okuyucular

[longman academic writing series 5 essays to research papers](#) - Nov 05 2022

web sep 18 2013 the longman academic writing series helps students master the academic writing skills needed to succeed in their academic careers the five level series spans writing topics from composing sentences to writing research papers each level covers the complete writing process from prewriting to revision

longman academic writing adult academic english language - Jan 27 2022

web longman academic writing develops learners writing skills to succeed in their academic careers this five level series takes students from composing sentences to writing research papers in addition to providing clear explanations and extensive practice this course consistently emphasizes sentence mechanics and grammar

longman academic reading series 5 levels pdf audio - Feb 08 2023

web dec 30 2017 the longman academic reading series is a five level series that prepares english language learners for academic work the aim of the series is to make students more effective and confident readers by providing high interest readings on academic subjects and by teaching

longman academic series pearson elt usa - May 11 2023

web longman academic reading series level 1 5 this five level reading series is organized by themes from academic disciplines authentic readings from a variety of sources engage students interest a step by step approach helps students develop academic knowledge vocabulary and reading strategies and skills

longman academic reading series 5 with essential online - Jan 07 2023

web the longman academic reading series is a five level series that prepares english language learners for academic work the aim of the series is to make students more effective and confident readers by providing high interest readings on academic subjects and by teaching them skills and strategies for effective reading vocabulary building

longman academic writing series 5 hepsiburada com - Jul 13 2023

web longman academic writing series 5 the longman academic writing series helps students master the academic writing skills needed to succeed in their academic careers the five level series spans writing topics from composing sentences to writing research papers each level covers the complete writing process from prewriting to revision level

[longman academic writing series 5 answer key pdf answers](#) - Jun 12 2023

web longman academic writing series 5 essays to research papers longman academic writing series helps students master the academic writing skills needed to succeed in their academic careers the five level series spans